







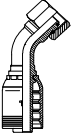
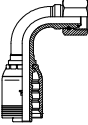

BRITISH STANDARD CONNECTIONS

REFERENCE	DESCRIPTION	PAGE	REFERENCE	DESCRIPTION	PAGE
HSS-MGC	 <p>BSP TAPERED MALE 60° CONE SEAT MASCHIO GAS CONICO SVASATO 60°</p>	213	HSS-FGO	 <p>BSP FEMALE 60° O-RING CONE TIEFFE NUT BS 5200 - ISO 12151-6 FEMMINA GAS OGIVA 60° O-RING DADO TIEFFE BS 5200 - ISO 12151-6</p>	214
HSS-MG	 <p>BSP PARALLEL MALE 60° CONE SEAT BS 5200 - ISO 12151-6 MASCHIO GAS CILINDRICO SVASATO 60° BS 5200 - ISO 12151-6</p>	213	HSS-FGO45	 <p>BSP FEMALE 60° O RING CONE 45° ELBOW - TIEFFE NUT BS 5200 - ISO 12151-6 FEMMINA GAS OGIVA 60° O-RING CURVA A 45° - DADO TIEFFE BS 5200 - ISO 12151-6</p>	214
			HSS-FGO90	 <p>BSP FEMALE 60° O RING CONE 90° ELBOW - TIEFFE NUT BS 5200 - ISO 12151-6 FEMMINA GAS OGIVA 60° O-RING CURVA A 90° - DADO TIEFFE BS 5200 - ISO 12151-6</p>	214

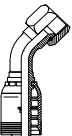
AMERICAN STANDARD CONNECTIONS - NPTF - JIC 37°

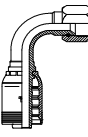
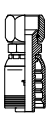
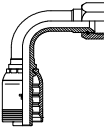
REFERENCE	DESCRIPTION	PAGE	REFERENCE	DESCRIPTION	PAGE
HSS-NPT	 <p>NPTF MALE 60° CONE SEAT SAE J516 MASCHIO NPTF SVASATO 60° SAE J516</p>	215	HSS-FIS45	 <p>JIC FEMALE 37° CONE SEAT 45° ELBOW - TIEFFE NUT SAE J516 - ISO 12151-5 FEMMINA JIC SVASATA 37° CURVA A 45° - DADO TIEFFE SAE J516 - ISO 12151-5</p>	216
HSS-MI	 <p>JIC MALE 37° CONE SAE J516 - ISO 12151-5 MASCHIO JIC CONO 37° SAE J516 - ISO 12151-5</p>	215	HSS-FIS90	 <p>JIC FEMALE 37° CONE SEAT 90° ELBOW - TIEFFE NUT SAE J516 - ISO 12151-5 FEMMINA JIC SVASATA 37° CURVA A 90° - DADO TIEFFE SAE J516 - ISO 12151-5</p>	216
HSS-FIC	 <p>JIC FEMALE 37° CONE SEAT DOUBLE EXAGON - TIEFFE NUT SAE J516 - ISO 12151-5 FEMMINA JIC SVASATA 37° DOPPIO ESAGONO - DADO TIEFFE SAE J516 - ISO 12151-5</p>	215	HSS-FIS90-K-	 <p>JIC FEMALE 37° CONE SEAT 90° ELBOW - LONG DROP - TIEFFE NUT SAE J516 - ISO 12151-5 FEMMINA JIC SVASATA 37° CURVA A 90° - LUNGA - DADO TIEFFE SAE J516 - ISO 12151-5</p>	216

AMERICAN STANDARD CONNECTIONS - ORFS (SAE J516 / ISO 12151-1)

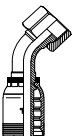
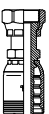
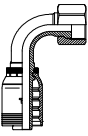
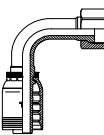
REFERENCE	DESCRIPTION	PAGE	REFERENCE	DESCRIPTION	PAGE
HSS-MRS	 <p>ORFS MALE MASCHIO ORFS</p>	217	HSS-FRS45	 <p>ORFS FEMALE 45° ELBOW - SLIP-ON NUT FEMMINA ORFS CURVA A 45° - DADO LIBERO</p>	218
HSS-FRC	 <p>ORFS FEMALE DOUBLE EXAGON - CRIMPED-BACK NUT FEMMINA ORFS DOPPIO ESAGONO - DADO PRESSATO</p>	217	HSS-FRS90	 <p>ORFS FEMALE 90° ELBOW - SHORT DROP SLIP-ON NUT FEMMINA ORFS CURVA A 90° - CORTA DADO LIBERO</p>	218
			HSS-FRS90-K-	 <p>ORFS FEMALE 90° ELBOW - LONG DROP SLIP-ON NUT FEMMINA ORFS CURVA A 90° - LUNGA DADO LIBERO</p>	218



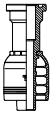
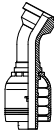
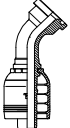
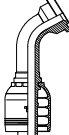
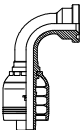
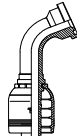
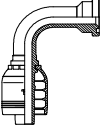
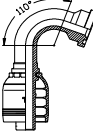
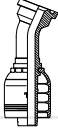

AMERICAN STANDARD CONNECTIONS - FLANGE CODE 61 (SAE J516 / ISO 12151-3)

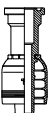
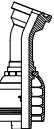
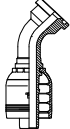
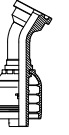
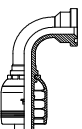
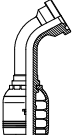
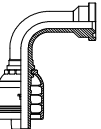
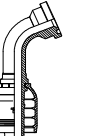
REFERENCE	DESCRIPTION	PAGE	REFERENCE	DESCRIPTION	PAGE
HSS-FL	 SAE CODE 61 FLANGE FLANGIA SAE CODE 61	219	HSS-FL30	 SAE CODE 61 FLANGE 30° ELBOW FLANGIA SAE CODE 61 CURVA A 30°	221
HSS-FL45	 SAE CODE 61 FLANGE 45° ELBOW FLANGIA SAE CODE 61 CURVA A 45°	219	HSS-FL60	 SAE CODE 61 FLANGE 60° ELBOW FLANGIA SAE CODE 61 CURVA A 60°	222
HSS-FL90	 SAE CODE 61 FLANGE 90° ELBOW FLANGIA SAE CODE 61 CURVA A 90°	220	HSS-FL67	 SAE CODE 61 FLANGE 67,5° ELBOW FLANGIA SAE CODE 61 CURVA A 67,5°	222
HSS-FL90-K-	 SAE CODE 61 FLANGE 90° ELBOW - LONG DROP FLANGIA SAE CODE 61 CURVA A 90° - LUNGA	220	HSS-FL110	 SAE CODE 61 FLANGE 110° ELBOW - LONG DROP FLANGIA SAE CODE 61 CURVA A 110° - LUNGA	222
HSS-FL22	 SAE CODE 61 FLANGE 22,5° ELBOW FLANGIA SAE CODE 61 CURVA A 22,5°	221			

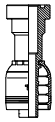
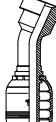

AMERICAN STANDARD CONNECTIONS - FLANGE CODE 62 (SAE J516 / ISO 12151-3)

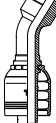
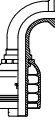
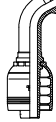
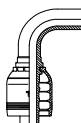
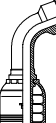
REFERENCE	DESCRIPTION	PAGE	REFERENCE	DESCRIPTION	PAGE
HSS-FP	 SAE CODE 62 FLANGE FLANGIA SAE CODE 62	223	HSS-FP22	 SAE CODE 62 FLANGE 22,5° ELBOW FLANGIA SAE CODE 62 CURVA A 22,5°	224
HSS-FP45	 SAE CODE 62 FLANGE 45° ELBOW FLANGIA SAE CODE 62 CURVA A 45°	223	HSS-FP30	 SAE CODE 62 FLANGE 30° ELBOW FLANGIA SAE CODE 62 CURVA A 30°	224
HSS-FP90	 SAE CODE 62 FLANGE 90° ELBOW FLANGIA SAE CODE 62 CURVA A 90°	223	HSS-FP60	 SAE CODE 62 FLANGE 60° ELBOW FLANGIA SAE CODE 62 CURVA A 60°	224
HSS-FP90-K-	 SAE CODE 62 FLANGE 90° ELBOW - LONG DROP FLANGIA SAE CODE 62 CURVA A 90° - LUNGA	223	HSS-FP67	 SAE CODE 62 FLANGE 67,5° ELBOW FLANGIA SAE CODE 62 CURVA A 67,5°	224

OEM CONNECTIONS - "SUPERCAT" FLANGE

REFERENCE	DESCRIPTION	PAGE	REFERENCE	DESCRIPTION	PAGE
HSS-YP	 "SUPERCAT" FLANGE FLANGIA "SUPERCAT"	225	HSS-YP22	 "SUPERCAT" FLANGE 22,5° ELBOW FLANGIA "SUPERCAT" CURVA A 22,5°	226
HSS-YP45	 "SUPERCAT" FLANGE 45° ELBOW FLANGIA "SUPERCAT" CURVA A 45°	225	HSS-YP30	 "SUPERCAT" FLANGE 30° ELBOW FLANGIA "SUPERCAT" CURVA A 30°	226
HSS-YP90	 "SUPERCAT" FLANGE 90° ELBOW FLANGIA "SUPERCAT" CURVA A 90°	225	HSS-YP60	 "SUPERCAT" FLANGE 60° ELBOW FLANGIA "SUPERCAT" CURVA A 60°	227
HSS-YP90-K-	 "SUPERCAT" FLANGE 90° ELBOW - LONG DROP FLANGIA "SUPERCAT" CURVA A 90° - LUNGA	225	HSS-YP67	 "SUPERCAT" FLANGE 67,5° ELBOW FLANGIA "SUPERCAT" CURVA A 67,5°	227
			DR	 D'RING SEAL FOR "SUPERCAT" FLANGES GUARNIZIONI D'RING PER FLANGE "SUPERCAT"	227

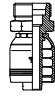
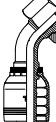
DIN STANDARD CONNECTIONS (DIN20066 / ISO12151-2)

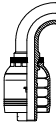
REFERENCE	DESCRIPTION	PAGE	REFERENCE	DESCRIPTION	PAGE
HSS-MM	 METRIC MALE 24° CONE SEAT MASCHIO METRICO SVASATO 24°	228	HSS-FOS45	 METRIC FEMALE 24° O'RING CONE 45° ELBOW - SLIP-ON NUT FEMM. METR. OGIVA 24° O'RING CURVA A 45° - DADO LIBERO	228
HSS-FOS	 METRIC FEMALE 24° O'RING CONE SLIP-ON NUT FEMMINA METRICA OGIVA 24° O'RING DADO LIBERO	228	HSS-FOS90	 METRIC FEMALE 24° O'RING CONE 90° ELBOW - SLIP-ON NUT FEMM. METR. OGIVA 24° O'RING CURVA A 90° - DADO LIBERO	228

MGC

BSP TAPERED MALE 60° CONE SEAT
MASCHIO GAS CONICO SVASATO 60°

AGR-K

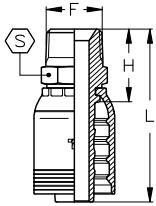

TIEFFE Part.N.	Hose Size			BSP Connection Size		Dimensions (mm)					Maximum W.P.	
	DN	Inch	Dash	F	Dash	H	L	S			bar	PSI
HSS2020MGC	31,5	1 1/4"	-20	1 1/4"-11	-20	51	118	46			210	3000
HSS2424MGC	38	1 1/2"	-24	1 1/2"-11	-24	54	137	50			185	2700
HSS3232MGC	51	2"	-32	2"-11	-32	64	160	65			175	2500

MG

BSP PARALLEL MALE 60° CONE SEAT
MASCHIO GAS CILINDRICO SVASATO 60°

AGR

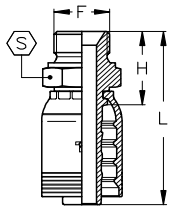

TIEFFE Part.N.	Hose Size			BSP Connection Size		Dimensions (mm)					Maximum W.P.	
	DN	Inch	Dash	F	Dash	H	L	S			bar	PSI
HSS2020MG	31,5	1 1/4"	-20	1 1/4"-11	-20	50	117	50			325	4700
HSS2024MG	31,5	1 1/4"	-20	1 1/2"-11	-24	53	120	55			290	4200
HSS2424MG	38	1 1/2"	-24	1 1/2"-11	-24	55	138	55			290	4200
HSS3232MG	51	2"	-32	2"-11	-32	63	159	70			250	3600

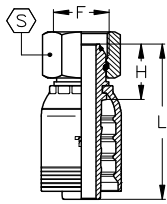
FGO
BSP FEMALE 60° O-RING CONE - TIEFFE NUT
FEMMINA GAS OGIVA 60° O-RING - DADO TIEFFE
DKOR

TIEFFE Part.N.	Hose Size			BSP Connection Size		Dimensions (mm)					Maximum W.P.		
	DN	Inch	Dash	F	Dash	H	L	S			bar	PSI	
HSS2020FGO	31,5	1 1/4"	-20	1 1/4"-11	-20	39	106	50			28,3x1,78	325	4700
HSS2024FGO	31,5	1 1/4"	-20	1 1/2"-11	-24	42	109	60			33,05x1,78	290	4200
HSS2424FGO	38	1 1/2"	-24	1 1/2"-11	-24	43	125	60			33,05x1,78	290	4200
HSS3232FGO	51	2"	-32	2"-11	-32	47	143	75			44,17x1,78	250	3600

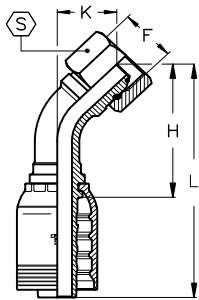
FGO45
BSP FEMALE 60° O-RING CONE - 45° ELBOW - TIEFFE NUT
FEMMINA GAS OGIVA 60° O-RING - CURVA A 45° - DADO TIEFFE
DKOR45

TIEFFE Part.N.	Hose Size			BSP Connection Size		Dimensions (mm)					Maximum W.P.	
	DN	Inch	Dash	F	Dash	H	L	S	K	O-RING	bar	PSI
HSS2020FGO45	31,5	1 1/4"	-20	1 1/4"-11	-20	103	169	43	50	28,3x1,78	325	4700
HSS2024FGO45	31,5	1 1/4"	-20	1 1/2"-11	-24	103	169	43	60	33,05x1,78	290	4200
HSS2424FGO45	38	1 1/2"	-24	1 1/2"-11	-24	123	206	51	60	33,05x1,78	290	4200
HSS3232FGO45	51	2"	-32	2"-11	-32	160	257	65	75	44,17x1,78	250	3600

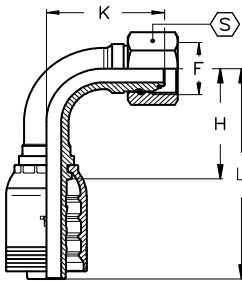
FGO90
BSP FEMALE 60° O-RING CONE - 90° ELBOW - TIEFFE NUT
FEMMINA GAS OGIVA 60° O-RING - CURVA A 90° - DADO TIEFFE
DKOR90

TIEFFE Part.N.	Hose Size			BSP Connection Size		Dimensions (mm)					Maximum W.P.	
	DN	Inch	Dash	F	Dash	H	L	S	K	O-RING	bar	PSI
HSS2020FGO90	31,5	1 1/4"	-20	1 1/4"-11	-20	87	154	88	50	28,3x1,78	325	4700
HSS2024FGO90	31,5	1 1/4"	-20	1 1/2"-11	-24	87	154	88	60	33,05x1,78	290	4200
HSS2424FGO90	38	1 1/2"	-24	1 1/2"-11	-24	105	188	104	60	33,05x1,78	290	4200
HSS3232FGO90	51	2"	-32	2"-11	-32	140	237	137	75	44,17x1,78	250	3600

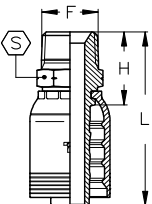
NPT	NPTF MALE 60° CONE SEAT MASCHIO NPTF SVASATO 60°											AGN		
	TIEFFE Part.N.	Hose Size			NPTF Connection Size		Dimensions (mm)					Maximum W.P.		
		DN	Inch	Dash	F	Dash	H	L	S			bar	PSI	
	HSS2016NPT	31,5	1 1/4"	-20	1"-11,5	-16	52,5	119	41				210	3000
	HSS2020NPT	31,5	1 1/4"	-20	1 1/4"-11,5	-20	55	121,5	46				210	3000
	HSS2024NPT	31,5	1 1/4"	-20	1 1/2"-11,5	-24	59	125,5	50				185	2700
	HSS2424NPT	38	1 1/2"	-24	1 1/2"-11,5	-24	61	143,5	50				185	2700
	HSS2432NPT	38	1 1/2"	-24	2"-11,5	-32	67,5	150	65				175	2500
	HSS3232NPT	51	2"	-32	2"-11,5	-32	70,5	167	65				175	2500

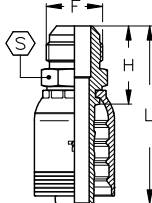
MI	JIC MALE 37° CONE MASCHIO JIC CONO 37°											AGJ		
	TIEFFE Part.N.	Hose Size			JIC 37° Connection Size		Dimensions (mm)					Maximum W.P.		
		DN	Inch	Dash	F	Dash	H	L	S			bar	PSI	
	HSS2016MI	31,5	1 1/4"	-20	1 5/16"-12	-16	48,5	115	41				280	4000
	HSS2020MI	31,5	1 1/4"	-20	1 5/8"-12	-20	50,5	117	46				210	3000
	HSS2024MI	31,5	1 1/4"	-20	1 7/8"-12	-24	55	121,5	50				185	2700
	HSS2424MI	38	1 1/2"	-24	1 7/8"-12	-24	57	139,5	50				185	2700
	HSS2432MI	38	1 1/2"	-24	2 1/2"-12	-32	65,5	148	65				175	2500
	HSS3232MI	51	2"	-32	2 1/2"-12	-32	68,5	165	65				175	2500

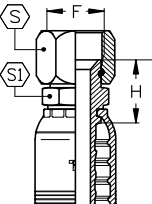
FIC	JIC FEMALE 37° CONE SEAT - DOUBLE EXAGON - TIEFFE NUT FEMMINA JIC SVASATA 37° - DOPPIO ESAGONO - DADO TIEFFE											DKJ		
	TIEFFE Part.N.	Hose Size			JIC 37° Connection Size		Dimensions (mm)					Maximum W.P.		
		DN	Inch	Dash	F	Dash	H	L	S	S1			bar	PSI
	HSS2016FIC	31,5	1 1/4"	-20	1 5/16"-12	-16	45,5	112	41	41			280	4000
	HSS2020FIC	31,5	1 1/4"	-20	1 5/8"-12	-20	48	114,5	50	41			210	3000
	HSS2024FIC	31,5	1 1/4"	-20	1 7/8"-12	-24	51	117,5	60	46			185	2700
	HSS2424FIC	38	1 1/2"	-24	1 7/8"-12	-24	53	135,5	60	46			185	2700
	HSS2432FIC	38	1 1/2"	-24	2 1/2"-12	-32	66	148,5	75	60			175	2500
	HSS3232FIC	51	2"	-32	2 1/2"-12	-32	69	165,5	75	60			175	2500

FIS45

JIC FEMALE 37° CONE SEAT - 45° ELBOW - TIEFFE NUT
FEMMINA JIC SVASATA 37° - CURVA A 45° - DADO TIEFFE

DKJ45

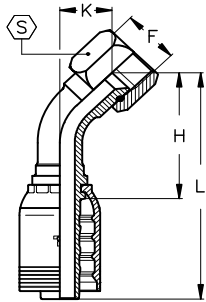

TIEFFE Part.N.	Hose Size			JIC 37° Connection Size		Dimensions (mm)				Maximum W.P.	
	DN	Inch	Dash	F	Dash	H	L	K	S	bar	PSI
HSS2016FIS45	31,5	1 1/4"	-20	1 5/16"-12	-16	100	167	41	41	280	4000
HSS2020FIS45	31,5	1 1/4"	-20	1 5/8"-12	-20	98	164	38	50	210	3000
HSS2024FIS45	31,5	1 1/4"	-20	1 7/8"-12	-24	99	165	39	60	185	2700
HSS2424FIS45	38	1 1/2"	-24	1 7/8"-12	-24	118	201	46	60	185	2700
HSS2432FIS45	38	1 1/2"	-24	2 1/2"-12	-32	122	204	50	75	175	2500
HSS3232FIS45	51	2"	-32	2 1/2"-12	-32	157	253	62	75	175	2500

FIS90

JIC FEMALE 37° CONE SEAT - 90° ELBOW - TIEFFE NUT
FEMMINA JIC SVASATA 37° - CURVA A 90° - DADO TIEFFE

DKJ90

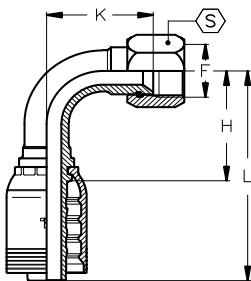

TIEFFE Part.N.	Hose Size			JIC 37° Connection Size		Dimensions (mm)				Maximum W.P.	
	DN	Inch	Dash	F	Dash	H	L	K	S	bar	PSI
HSS2016FIS90	31,5	1 1/4"	-20	1 5/16"-12	-16	87	154	84	41	280	4000
HSS2020FIS90	31,5	1 1/4"	-20	1 5/8"-12	-20	87	154	81	50	210	3000
HSS2024FIS90	31,5	1 1/4"	-20	1 7/8"-12	-24	87	154	82	60	185	2700
HSS2424FIS90	38	1 1/2"	-24	1 7/8"-12	-24	105	188	97	60	185	2700
HSS2432FIS90	38	1 1/2"	-24	2 1/2"-12	-32	105	188	102	75	175	2500
HSS3232FIS90	51	2"	-32	2 1/2"-12	-32	140	237	132	75	175	2500

FIS90

LONG DROP

JIC FEMALE 37° CONE SEAT - 90° ELBOW - LONG DROP - TIEFFE NUT
FEMMINA JIC SVASATA 37° - CURVA A 90° LUNGA - DADO TIEFFE

DKJ90
LONG DROP

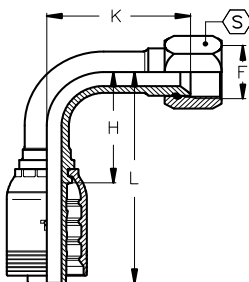

TIEFFE Part.N.	Hose Size			JIC 37° Connection Size		Dimensions (mm)				Maximum W.P.	
	DN	Inch	Dash	F	Dash	H	L	K	S	bar	PSI
HSS2020FIS90-K136	31,5	1 1/4"	-20	1 5/8"-12	-20	87	154	136	50	210	3000
HSS2424FIS90-K162	38	1 1/2"	-24	1 7/8"-12	-24	105	188	162	60	185	2700
HSS3232FIS90-K220	51	2"	-32	2 1/2"-12	-32	140	137	220	75	175	2500

FRS45

ORFS FEMALE - 45° ELBOW - SLIP-ON NUT
FEMMINA ORFS - CURVA A 45° - DADO LIBERO

DK ORFS 45

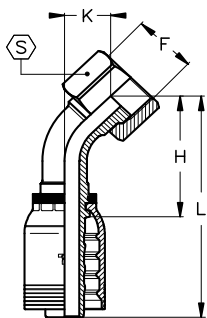

TIEFFE Part.N.	Hose Size			ORFS Connection Size		Dimensions (mm)				Maximum W.P.	
	DN	Inch	Dash	F	Dash	H	L	K	S	bar	PSI
HSS2020FRS45	31,5	1 1/4"	-20	1 11/16"-12	-20	93	159	34	50	345	5000
HSS2424FRS45	38	1 1/2"	-24	2"-12	-24	113	195	41	60	290	4200

FRS90

ORFS FEMALE - 90° ELBOW - SLIP-ON NUT
FEMMINA ORFS - CURVA A 90° - DADO LIBERO

DK ORFS 90

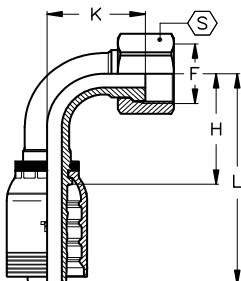

TIEFFE Part.N.	Hose Size			ORFS Connection Size		Dimensions (mm)				Maximum W.P.	
	DN	Inch	Dash	F	Dash	H	L	K	S	bar	PSI
HSS2020FRS90	31,5	1 1/4"	-20	1 11/16"-12	-20	87	153	75	50	345	5000
HSS2424FRS90	38	1 1/2"	-24	2"-12	-24	105	187	90	60	290	4200

DK ORFS 90 □LO

ORFS FEMALE - 90° ELBOW - LONG DROP - SLIP-ON NUT
FEMMINA ORFS - CURVA A 90° - LUNGA - DADO LIBERO

**DK ORFS 90
LONG DROP**

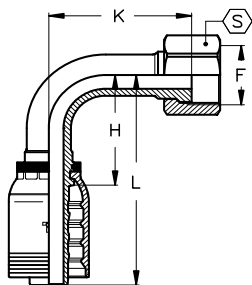

TIEFFE Part.N.	Hose Size			ORFS Connection Size		Dimensions (mm)				Maximum W.P.	
	DN	Inch	Dash	F	Dash	H	L	K	S	bar	PSI
HSS2020FRS90-K130	31,5	1 1/4"	-20	1 11/16"-12	-20	87	153	130	50	345	5000
HSS2424FRS90-K155	38	1 1/2"	-24	2"-12	-24	105	187	155	60	290	4200

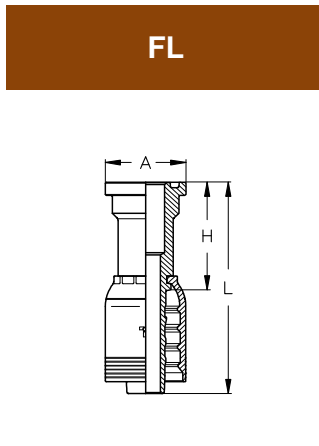

SAE CODE 61 FLANGE
FLANGIA SAE CODE 61

SFL

TIEFFE Part.N.	Hose Size			Flange Size Connection		Dimensions (mm)					Maximum W.P.	
	DN	Inch	Dash	Inch	Dash	H	L	A			bar	PSI
HSS2016FL	31,5	1 1/4"	-20	1"	-16	64	130,5	44,5			350	5000
HSS2020FL	31,5	1 1/4"	-20	1 1/4"	-20	64	130,5	50,8			280	4000
HSS2024FL	31,5	1 1/4"	-20	1 1/2"	-24	68	134,5	60,4			210	3000
HSS2032FL	31,5	1 1/4"	-20	2"	-32	75	141,5	71,4			210	3000
HSS2424FL	38	1 1/2"	-24	1 1/2"	-24	73	155,5	60,4			210	3000
HSS2432FL	38	1 1/2"	-24	2"	-32	76	158,5	71,4			210	3000
HSS3232FL	51	2"	-32	2"	-32	77	176,5	71,4			210	3000
HSS3240FL	51	2"	-32	2 1/2"	40	90	186,5	84,1			175	2500

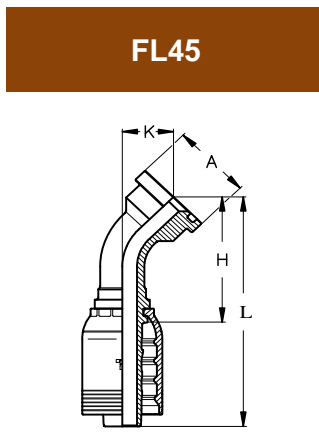

SAE CODE 61 FLANGE - 45° ELBOW
FLANGIA SAE CODE 61 - CURVA A 45°

SFL45

TIEFFE Part.N.	Hose Size			Flange Size Connection		Dimensions (mm)					Maximum W.P.	
	DN	Inch	Dash	Inch	Dash	H	L	K	A		bar	PSI
HSS2016FL45	31,5	1 1/4"	-20	1"	-16	96	163	37	44,5		350	5000
HSS2020FL45	31,5	1 1/4"	-20	1 1/4"	-20	91	157	32	50,8		280	4000
HSS2024FL45	31,5	1 1/4"	-20	1 1/2"	-24	91	157	32	60,4		210	3000
HSS2424FL45	38	1 1/2"	-24	1 1/2"	-24	108	191	36	60,4		210	3000
HSS2432FL45	38	1 1/2"	-24	2"	-32	107	189	35	71,4		210	3000
HSS3232FL45	51	2"	-32	2"	-32	151	245	57	71,4		210	3000
HSS3240FL45	51	2"	-32	2 1/2"	-40	146	243	51	84,1		175	2500

FL90

SAE CODE 61 FLANGE - 90° ELBOW
FLANGIA SAE CODE 61 - CURVA A 90°

SFL90

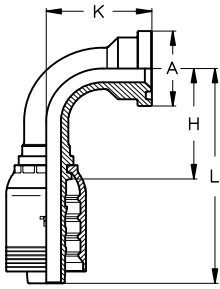

TIEFFE Part.N.	Hose Size			Flange Size Connection		Dimensions (mm)					Maximum W.P.	
	DN	Inch	Dash	Inch	Dash	H	L	K	A		bar	PSI
HSS2016FL90	31,5	1 1/4"	-20	1"	-16	87	154	79	44,5		350	5000
HSS2020FL90	31,5	1 1/4"	-20	1 1/4"	-20	87	154	71	50,8		280	4000
HSS2024FL90	31,5	1 1/4"	-20	1 1/2"	-24	87	154	71	60,4		210	3000
HSS2424FL90	38	1 1/2"	-24	1 1/2"	-24	105	188	83	60,4		210	3000
HSS2432FL90	38	1 1/2"	-24	2"	-32	105	188	81	71,4		210	3000
HSS3232FL90	51	2"	-32	2"	-32	140	237	122	71,4		210	3000
HSS3240FL90	51	2"	-32	2 1/2"	-40	140	237	117	84,1		175	2500

FL 90

LONG DROP

SAE CODE 61 FLANGE - 90° ELBOW - LONG DROP
FLANGIA SAE CODE 61 - CURVA A 90° - LUNGA

SFL90
LONG DROP

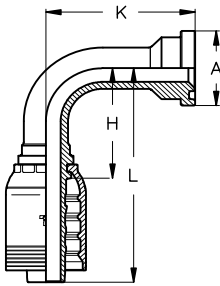

TIEFFE Part.N.	Hose Size			Flange Size Connection		Dimensions (mm)					Maximum W.P.	
	DN	Inch	Dash	Inch	Dash	H	L	K	A		bar	PSI
HSS2020FL90-K91	31,5	1 1/4"	-20	1 1/4"	-20	87	154	91	50,8		280	4000
HSS2020FL90-K102	31,5	1 1/4"	-20	1 1/4"	-20	87	154	102	50,8		280	4000
HSS2020FL90-K112	31,5	1 1/4"	-20	1 1/4"	-20	87	154	112	50,8		280	4000
HSS2020FL90-K130	31,5	1 1/4"	-20	1 1/4"	-20	87	154	130	50,8		280	4000
HSS2020FL90-K168	31,5	1 1/4"	-20	1 1/4"	-20	87	154	168	50,8		280	4000
HSS2024FL90-K118	31,5	1 1/4"	-20	1 1/2"	-24	87	154	118	60,4		210	3000
HSS2024FL90-K130	31,5	1 1/4"	-20	1 1/2"	-24	87	154	130	60,4		210	3000
HSS2424FL90-K148	38	1 1/2"	-24	1 1/2"	-24	105	188	148	60,4		210	3000
HSS2424FL90-K172	38	1 1/2"	-24	1 1/2"	-24	105	188	172	60,4		210	3000
HSS2432FL90-K115	38	1 1/2"	-24	2"	-32	105	188	115	71,4		210	3000
HSS2432FL90-K172	38	1 1/2"	-24	2"	-32	105	188	172	71,4		210	3000
HSS3232FL90-K165	51	2"	-32	2"	-32	140	237	165	71,4		210	3000
HSS3232FL90-K203	51	2"	-32	2"	-32	140	237	203	71,4		210	3000

FL22

SAE CODE 61 FLANGE - 22,5° ELBOW
FLANGIA SAE CODE 61 - CURVA A 22,5°

SFL22,5

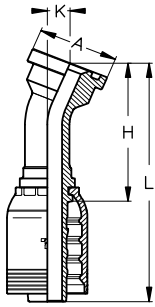

TIEFFE Part.N.	Hose Size			Flange Size Connection		Dimensions (mm)					Maximum W.P.	
	DN	Inch	Dash	Inch	Dash	H	L	K	A		bar	PSI
HSS2020FL22	31,5	1 1/4"	-20	1 1/4"	-20	100	166	13	50,8		280	4000
HSS2024FL22	31,5	1 1/4"	-20	1 1/2"	-24	100	166	13	60,4		210	3000
HSS2424FL22	38	1 1/2"	-24	1 1/2"	-24	118	201	15	60,4		210	3000
HSS2432FL22	38	1 1/2"	-24	2"	-32	116	199	14	71,4		210	3000
HSS3232FL22	51	2"	-32	2"	-32	165	262	22	71,4		210	3000

FL30

SAE CODE 61 FLANGE - 30° ELBOW
FLANGIA SAE CODE 61 - CURVA A 30°

SFL30

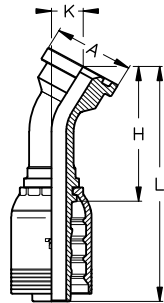

TIEFFE Part.N.	Hose Size			Flange Size Connection		Dimensions (mm)					Maximum W.P.	
	DN	Inch	Dash	Inch	Dash	H	L	K	A		bar	PSI
HSS2020FL30	31,5	1 1/4"	-20	1 1/4"	-20	98	164	19	50,8		280	4000
HSS2024FL30	31,5	1 1/4"	-20	1 1/2"	-24	98	164	19	60,4		210	3000
HSS2424FL30	38	1 1/2"	-24	1 1/2"	-24	116	199	22	60,4		210	3000
HSS2432FL30	38	1 1/2"	-24	2"	-32	114	197	21	71,4		210	3000
HSS3232FL30	51	2"	-32	2"	-32	162	258	31	71,4		210	3000

FL60

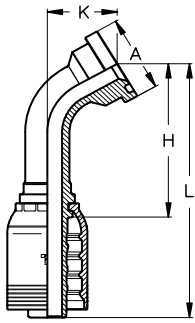

SAE CODE 61 FLANGE - 60° ELBOW
FLANGIA SAE CODE 61 - CURVA A 60°

SFL60

TIEFFE Part.N.	Hose Size			Flange Size Connection		Dimensions (mm)					Maximum W.P.	
	DN	Inch	Dash	Inch	Dash	H	L	K	A		bar	PSI
HSS2020FL60	31,5	1 1/4"	-20	1 1/4"	-20	118	184	45	50,8		280	4000
HSS2024FL60	31,5	1 1/4"	-20	1 1/2"	-24	118	184	45	60,4		210	3000
HSS2424FL60	38	1 1/2"	-24	1 1/2"	-24	140	223	52	60,4		210	3000
HSS2432FL60	38	1 1/2"	-24	2"	-32	139	222	50	71,4		210	3000
HSS3232FL60	51	2"	-32	2"	-32	192	289	73	71,4		210	3000

FL67

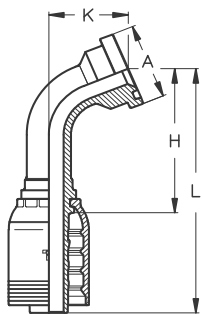

SAE CODE 61 FLANGE - 67,5° ELBOW
FLANGIA SAE CODE 61 - CURVA A 67,5°

SFL67,5

TIEFFE Part.N.	Hose Size			Flange Size Connection		Dimensions (mm)					Maximum W.P.	
	DN	Inch	Dash	Inch	Dash	H	L	K	A		bar	PSI
HSS2020FL67	31,5	1 1/4"	-20	1 1/4"	-20	111	178	52	50,8		280	4000
HSS2024FL67	31,5	1 1/4"	-20	1 1/2"	-24	111	178	52	60,4		210	3000
HSS2424FL67	38	1 1/2"	-24	1 1/2"	-24	133	216	60	60,4		210	3000
HSS2432FL67	38	1 1/2"	-24	2"	-32	132	215	58	71,4		210	3000
HSS3232FL67	51	2"	-32	2"	-32	181	278	84	71,4		210	3000

FL110

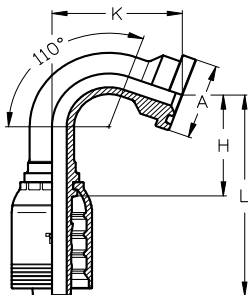

SAE CODE 61 FLANGE - 110° ELBOW
FLANGIA SAE CODE 61 - CURVA A 110°

SFL110

TIEFFE Part.N.	Hose Size			Flange Size Connection		Dimensions (mm)					Maximum W.P.	
	DN	Inch	Dash	Inch	Dash	H	L	K	A		bar	PSI
HSS2020FL110	31,5	1 1/4"	-20	1 1/4"	-20	82	148	83	50,8		280	4000
HSS2024FL110	31,5	1 1/4"	-20	1 1/2"	-24	82	148	83	60,4		210	3000
HSS2424FL110	38	1 1/2"	-24	1 1/2"	-24	95	178	97	60,4		210	3000
HSS3232FL110	51	2"	-32	2"	-32	124	220	142	71,4		210	3000

FP

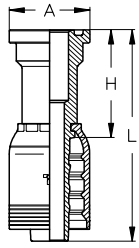

SAE CODE 62 FLANGE FLANGIA SAE CODE 62											SFS	
TIEFFE Part.N.	Hose Size			Flange Size Connection		Dimensions (mm)					Maximum W.P.	
	DN	Inch	Dash	Inch	Dash	H	L	A			bar	PSI
HSS2016FP	31,5	1 1/4"	-20	1"	-16	70	136,5	47,6			415	6000
HSS2020FP	31,5	1 1/4"	-20	1 1/4"	-20	70	136,5	54			415	6000
HSS2024FP	31,5	1 1/4"	-20	1 1/2"	-24	80	146,5	63,5			415	6000
HSS2424FP	38	1 1/2"	-24	1 1/2"	-24	84	116,5	63,5			415	6000
HSS2432FP	38	1 1/2"	-24	2"	-32	99	181,5	79,4			415	6000
HSS3232FP	51	2"	-32	2"	-32	100	196,5	79,4			345	5000

FP45

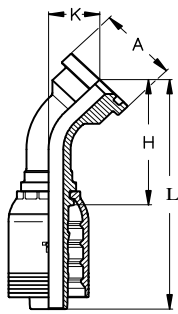

SAE CODE 62 FLANGE - 45° ELBOW FLANGIA SAE CODE 62 - CURVA A 45°											SFS45	
TIEFFE Part.N.	Hose Size			Flange Size Connection		Dimensions (mm)					Maximum W.P.	
	DN	Inch	Dash	Inch	Dash	H	L	K	A		bar	PSI
HSS2016FP45	31,5	1 1/4"	-20	1"	-16	96	163	37	47,6		415	6000
HSS2020FP45	31,5	1 1/4"	-20	1 1/4"	-20	93	160	34	54		415	6000
HSS2024FP45	31,5	1 1/4"	-20	1 1/2"	-24	94	161	35	63,5		415	6000
HSS2424FP45	38	1 1/2"	-24	1 1/2"	-24	112	195	40	63,5		415	6000
HSS2432FP45	38	1 1/2"	-24	2"	-32	115	198	43	79,4		415	6000
HSS3232FP45	51	2"	-32	2"	-32	150	247	56	79,4		345	5000

FP90

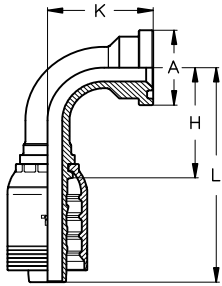

SAE CODE 62 FLANGE - 90° ELBOW FLANGIA SAE CODE 62 - CURVA A 90°											SFS90	
TIEFFE Part.N.	Hose Size			Flange Size Connection		Dimensions (mm)					Maximum W.P.	
	DN	Inch	Dash	Inch	Dash	H	L	K	A		bar	PSI
HSS2016FP90	31,5	1 1/4"	-20	1"	-16	87	154	79	47,6		415	6000
HSS2020FP90	31,5	1 1/4"	-20	1 1/4"	-20	87	154	74	54		415	6000
HSS2024FP90	31,5	1 1/4"	-20	1 1/2"	-24	87	154	76	63,5		415	6000
HSS2424FP90	38	1 1/2"	-24	1 1/2"	-24	105	188	88	63,5		415	6000
HSS2432FP90	38	1 1/2"	-24	2"	-32	105	188	93	79,4		415	6000
HSS3232FP90	51	2"	-32	2"	-32	140	237	123	79,4		345	5000

FP90 □ LONG DR

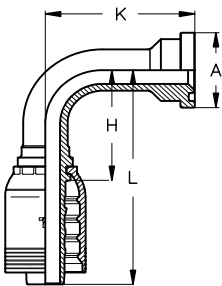

SAE CODE 62 FLANGE - 90° ELBOW - LONG DROP FLANGIA SAE CODE 62 - CURVA A 90° - LUNGA											SFS90 LONG DROP	
TIEFFE Part.N.	Hose Size			Flange Size Connection		Dimensions (mm)					Maximum W.P.	
	DN	Inch	Dash	Inch	Dash	H	L	K	A		bar	PSI
HSS2020FP90-K120	31,5	1 1/4"	-20	1 1/4"	-20	87	154	120	54		415	6000

FP22

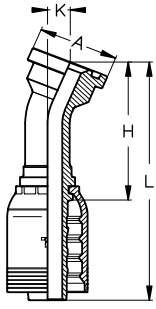

SAE CODE 62 FLANGE - 22,5° ELBOW
FLANGIA SAE CODE 62 - CURVA A 22,5°

SFS22,5

TIEFFE Part.N.	Hose Size			Flange Size Connection		Dimensions (mm)					Maximum W.P.	
	DN	Inch	Dash	Inch	Dash	H	L	K	A		bar	PSI
HSS2020FP22	31,5	1 1/4"	-20	1 1/4"	-20	103	169	15	54		415	6000
HSS2024FP22	31,5	1 1/4"	-20	1 1/2"	-24	104	171	15	63,5		415	6000
HSS2424FP22	38	1 1/2"	-24	1 1/2"	-24	123	206	17	63,5		415	6000
HSS2432FP22	38	1 1/2"	-24	2"	-32	127	210	19	79,4		415	6000
HSS3232FP22	51	2"	-32	2"	-32	166	263	24	79,4		345	5000

FP30

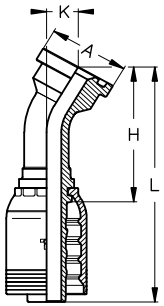

SAE CODE 62 FLANGE - 30° ELBOW
FLANGIA SAE CODE 62 - CURVA A 30°

SFS30

TIEFFE Part.N.	Hose Size			Flange Size Connection		Dimensions (mm)					Maximum W.P.	
	DN	Inch	Dash	Inch	Dash	H	L	K	A		bar	PSI
HSS2020FP30	31,5	1 1/4"	-20	1 1/4"	-20	100	167	20	54		415	6000
HSS2024FP30	31,5	1 1/4"	-20	1 1/2"	-24	102	168	21	63,5		415	6000
HSS2424FP30	38	1 1/2"	-24	1 1/2"	-24	121	203	24	63,5		415	6000
HSS2432FP30	38	1 1/2"	-24	2"	-32	124	207	26	79,4		415	6000
HSS3232FP30	51	2"	-32	2"	-32	162	259	34	79,4		345	5000

FP60

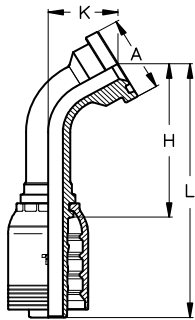

SAE CODE 62 FLANGE - 60° ELBOW
FLANGIA SAE CODE 62 - CURVA A 60°

SFS60

TIEFFE Part.N.	Hose Size			Flange Size Connection		Dimensions (mm)					Maximum W.P.	
	DN	Inch	Dash	Inch	Dash	H	L	K	A		bar	PSI
HSS2020FP60	31,5	1 1/4"	-20	1 1/4"	-20	119	185	47	54		415	6000
HSS2024FP60	31,5	1 1/4"	-20	1 1/2"	-24	120	186	49	63,5		415	6000
HSS2424FP60	38	1 1/2"	-24	1 1/2"	-24	143	225	56	63,5		415	6000
HSS2432FP60	38	1 1/2"	-24	2"	-32	145	228	60	79,4		415	6000
HSS3232FP60	51	2"	-32	2"	-32	193	289	79	79,4		345	5000

FP67

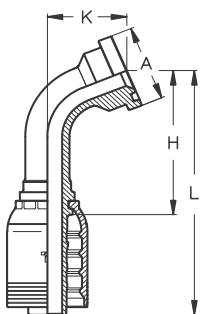

SAE CODE 62 FLANGE - 67,5° ELBOW
FLANGIA SAE CODE 62 - CURVA A 67,5°

SFS67,5

TIEFFE Part.N.	Hose Size			Flange Size Connection		Dimensions (mm)					Maximum W.P.	
	DN	Inch	Dash	Inch	Dash	H	L	K	A		bar	PSI
HSS2020FP67	31,5	1 1/4"	-20	1 1/4"	-20	112	179	54	54		415	6000
HSS2024FP67	31,5	1 1/4"	-20	1 1/2"	-24	113	180	56	63,5		415	6000
HSS2424FP67	38	1 1/2"	-24	1 1/2"	-24	135	217	65	63,5		415	6000
HSS2432FP67	38	1 1/2"	-24	2"	-32	137	219	69	79,4		415	6000
HSS3232FP67	51	2"	-32	2"	-32	182	278	90	79,4		345	5000

YP

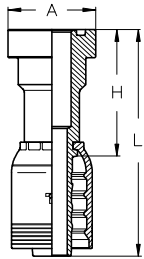

"SUPERCAT" FLANGE FLANGIA "SUPERCAT"											SFS SUPERCAT	
TIEFFE Part.N.	Hose Size			Flange Size Connection		Dimensions (mm)					Maximum W.P.	
	DN	Inch	Dash	Inch	Dash	H	L	A			bar	PSI
HSS2020YP	31,5	1 1/4"	-20	1 1/4"	-20	88	154,4	54			420	6000
HSS2024YP	31,5	1 1/4"	-20	1 1/2"	-24	88	154,5	63,5			420	6000
HSS2424YP	38	1 1/2"	-24	1 1/2"	-24	84	166,5	63,5			420	6000
HSS2432YP	38	1 1/2"	-24	2"	-32	110	192,5	79,4			420	6000
HSS3232YP	51	2"	-32	2"	-32	130	226,5	79,4			350	5000

YP45

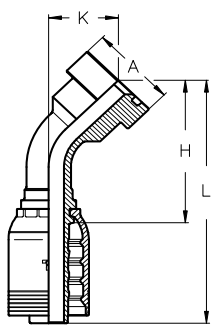

"SUPERCAT" FLANGE - 45° ELBOW FLANGIA "SUPERCAT" - CURVA A 45°											SFS45 SUPERCAT	
TIEFFE Part.N.	Hose Size			Flange Size Connection		Dimensions (mm)					Maximum W.P.	
	DN	Inch	Dash	Inch	Dash	H	L	K	A		bar	PSI
HSS2020YP45	31,5	1 1/4"	-20	1 1/4"	-20	96	162	36	54		420	6000
HSS2024YP45	31,5	1 1/4"	-20	1 1/2"	-24	96	162	36	63,5		420	6000
HSS2424YP45	38	1 1/2"	-24	1 1/2"	-24	114	196	41	63,5		420	6000
HSS2432YP45	38	1 1/2"	-24	2"	-32	116	199	44	79,4		420	6000
HSS3232YP45	51	2"	-32	2"	-32	152	250	57	79,4		350	5000

YP90

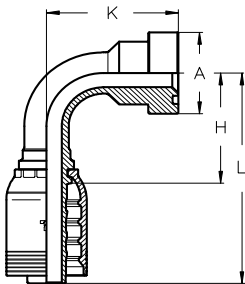

"SUPERCAT" FLANGE - 90° ELBOW FLANGIA "SUPERCAT" - CURVA A 90°											SFS90 SUPERCAT	
TIEFFE Part.N.	Hose Size			Flange Size Connection		Dimensions (mm)					Maximum W.P.	
	DN	Inch	Dash	Inch	Dash	H	L	K	A		bar	PSI
HSS2020YP90	31,5	1 1/4"	-20	1 1/4"	-20	87	154	77	54		420	6000
HSS2024YP90	31,5	1 1/4"	-20	1 1/2"	-24	87	154	78	63,5		420	6000
HSS2424YP90	38	1 1/2"	-24	1 1/2"	-24	105	188	90	63,5		420	6000
HSS2432YP90	38	1 1/2"	-24	2"	-32	105	188	94	79,4		420	6000
HSS3232YP90	51	2"	-32	2"	-32	140	237	125	79,4		350	5000

**YP90
LONG DROP**

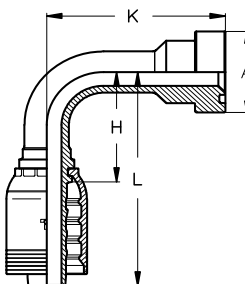

"SUPERCAT" FLANGE - 90° ELBOW - LONG DROP FLANGIA "SUPERCAT" - CURVA A 90° - LUNGA											SFS90 SUPERCAT LONG DROP	
TIEFFE Part.N.	Hose Size			Flange Size Connection		Dimensions (mm)					Maximum W.P.	
	DN	Inch	Dash	Inch	Dash	H	L	K	A		bar	PSI
HSS2020YP90-K150	31,5	1 1/4"	-20	1 1/4"	-20	87	154	150	54		420	6000
HSS2024YP90-K135	31,5	1 1/4"	-20	1 1/2"	-24	87	154	135	63,5		420	6000
HSS2424YP90-K106	38	1 1/2"	24	1 1/2"	-24	105	188	106	63,5		420	6000

YP22

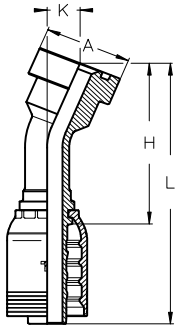

"SUPERCAT" FLANGE - 22,5° ELBOW
FLANGIA "SUPERCAT" - CURVA A 22,5°

SFS22,5
SUPERCAT

TIEFFE Part.N.	Hose Size			Flange Size Connection		Dimensions (mm)						Maximum W.P.	
	DN	Inch	Dash	Inch	Dash	H	L	K	A			bar	PSI
HSS2020YP22	31,5	1 1/4"	-20	1 1/4"	-20	406	172	16	54			420	6000
HSS2024YP22	31,5	1 1/4"	-20	1 1/2"	-24	406	174	16	63,5			420	6000
HSS2424YP22	38	1 1/2"	-24	1 1/2"	-24	125	208	18	63,5			420	6000
HSS2432YP22	38	1 1/2"	-24	2"	-32	129	211	19	79,4			420	6000
HSS3232YP22	51	2"	-32	2"	-32	168	265	25	79,4			350	5000

YP30

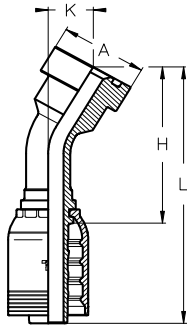

"SUPERCAT" FLANGE - 30° ELBOW
FLANGIA "SUPERCAT" - CURVA A 30°

SFS30
SUPERCAT

TIEFFE Part.N.	Hose Size			Flange Size Connection		Dimensions (mm)						Maximum W.P.	
	DN	Inch	Dash	Inch	Dash	H	L	K	A			bar	PSI
HSS2020YP30	31,5	1 1/4"	-20	1 1/4"	-20	103	170	22	54			420	6000
HSS2024YP30	31,5	1 1/4"	-20	1 1/2"	-24	104	170	23	63,5			420	6000
HSS2424YP30	38	1 1/2"	-24	1 1/2"	-24	123	205	25	63,5			420	6000
HSS2432YP30	38	1 1/2"	-24	2"	-32	126	208	27	79,4			420	6000
HSS3232YP30	51	2"	-32	2"	-32	164	264	35	79,4			350	5000

YP60

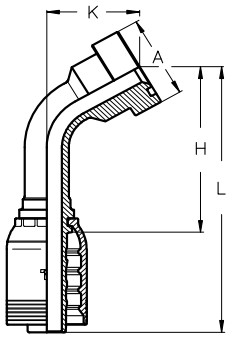

"SUPERCAT" FLANGE - 60° ELBOW
FLANGIA "SUPERCAT" - CURVA A 60°

SFS60
SUPERCAT

TIEFFE Part.N.	Hose Size			Flange Size Connection		Dimensions (mm)					Maximum W.P.	
	DN	Inch	Dash	Inch	Dash	H	L	K	A		bar	PSI
HSS2020YP60	31,5	1 1/4"	-20	1 1/4"	-20	121	187	50	54		420	6000
HSS2024YP60	31,5	1 1/4"	-20	1 1/2"	-24	121	187	51	63,5		420	6000
HSS2424YP60	38	1 1/2"	-24	1 1/2"	-24	144	226	58	63,5		420	6000
HSS2432YP60	38	1 1/2"	-24	2"	-32	146	228	61	79,4		420	6000
HSS3232YP60	51	2"	-32	2"	-32	194	290	81	79,4		350	5000

YP67

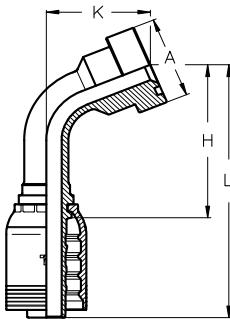

"SUPERCAT" FLANGE - 67,5° ELBOW
FLANGIA "SUPERCAT" - CURVA A 67,5°

SFS67,5
SUPERCAT

TIEFFE Part.N.	Hose Size			Flange Size Connection		Dimensions (mm)					Maximum W.P.	
	DN	Inch	Dash	Inch	Dash	H	L	K	A		bar	PSI
HSS2020YP67	31,5	1 1/4"	-20	1 1/4"	-20	114	181	57	54		420	6000
HSS2024YP67	31,5	1 1/4"	-20	1 1/2"	-24	114	181	58	63,5		420	6000
HSS2424YP67	38	1 1/2"	-24	1 1/2"	-24	137	219	66	63,5		420	6000
HSS2432YP67	38	1 1/2"	-24	2"	-32	138	220	69	79,4		420	6000
HSS3232YP67	51	2"	-32	2"	-32	184	280	92	79,4		350	5000

D'RING SEAL FOR "SUPERCAT" FLANGES
GUARNIZIONI D'RING PER FLANGE "SUPERCAT"

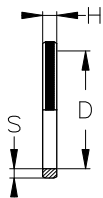

TIEFFE Part.N.	Flange Connection		Dimensions (mm)		
	Inch	Dash	D	H	S
DR20	1 1/4"	-20	38,1	5	3,5
DR24	1 1/2"	-24	44,5	5	3,5
DR32	2"	-32	63,9	5	3,5

MM-S

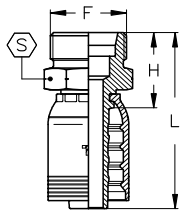

METRIC MALE - 24° CONE SEAT - HEAVY DUTY												CES	
TIEFFE Part.N.	Hose Size			METRIC 24° Connection		Dimensions (mm)					Maximum W.P.		
	DN	Inch	Dash	F	Pipe	H	L	S			bar	PSI	
HSS20MM30S	31,5	1 1/4"	-20	M42x2	30S	47	113	46			325	4700	
HSS20MM38S	31,5	1 1/4"	-24	M52x2	38S	51	117	55			325	4700	
HSS24MM38S	38	1 1/2"	-24	M52x2	38S	53	135	55			290	4200	

FOS-S

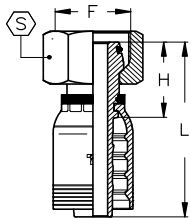

METRIC FEMALE 24° O'RING CONE - HEAVY DUTY - SLIP-ON NUT												DKOS	
TIEFFE Part.N.	Hose Size			METRIC 24° Connection		Dimensions (mm)					Maximum W.P.		
	DN	Inch	Dash	F	Pipe	H	L	S	O-RING		bar	PSI	
HSS20FOS30S	31,5	1 1/4"	-20	M42x2	30S	43	109	50	25,3x2,4		325	4700	
HSS20FOS38S	31,5	1 1/4"	-20	M52x2	38S	48	115	60	33,3x2,4		325	4700	
HSS24FOS38S	38	1 1/2"	-24	M52x2	38S	51	133	60	33,3x2,4		290	4200	

FOS-S45

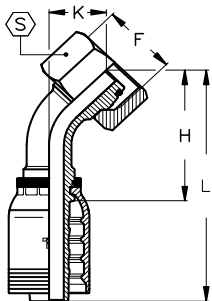

METRIC FEMALE 24° O'RING CONE - 45° ELBOW - HEAVY DUTY - SLIP-ON NUT												DKOS45	
TIEFFE Part.N.	Hose Size			METRIC 24° Connection		Dimensions (mm)					Maximum W.P.		
	DN	Inch	Dash	F	Pipe	H	L	K	S	O-RING	bar	PSI	
HSS20FOS30S45	31,5	1 1/4"	-20	M42x2	30S	100	166	40	50	25,3x2,4	325	4700	
HSS20FOS38S45	31,5	1 1/4"	-20	M52x2	38S	97	164	38	60	33,3x2,4	325	4700	
HSS24FOS38S45	38	1 1/2"	-24	M52x2	38S	121	203	48	60	33,3x2,4	290	4200	

FOS-S90

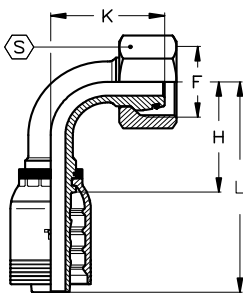

METRIC FEMALE 24° O'RING CONE - 90° ELBOW - HEAVY DUTY - SLIP-ON NUT												DKOS90	
TIEFFE Part.N.	Hose Size			METRIC 24° Connection		Dimensions (mm)					Maximum W.P.		
	DN	Inch	Dash	F	Pipe	H	L	K	S	O-RING	bar	PSI	
HSS20FOS30S90	31,5	1 1/4"	-20	M42x2	30S	87	154	83	50	25,3x2,4	325	4700	
HSS20FOS38S90	31,5	1 1/4"	-20	M52x2	38S	87	154	80	60	33,3x2,4	325	4700	
HSS24FOS38S90	38	1 1/2"	-24	M52x2	38S	105	188	100	60	33,3x2,4	290	4200	

OUTSIDE SKIVE

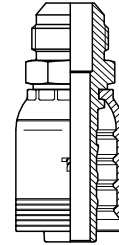

HSS

OUTSIDE SKIVE

RUBBER HOSES STEEL WIRE SPIRAL - TUBI GOMMA SPIRALATI ACCIAIO

Hose Size			ISO 3862 R13 SAE100 R13			ISO 3862 R15 SAE100 R15												Collapse control mandrel Spina controllo collasso			
			"HSS" Fitting Raccordo "HSN"	Skiving length Lungh. di pelatura	Ø Swage (Ref.) Ø Press. (Rif.)	"HSS" Fitting Raccordo "HSN"	Skiving length Lungh. di pelatura	Ø Swage (Ref.) Ø Press. (Rif.)	"HSS" Fitting Raccordo "HSN"	Skiving length Lungh. di pelatura	Ø Swage (Ref.) Ø Press. (Rif.)	"HSS" Fitting Raccordo "HSN"	Skiving length Lungh. di pelatura	Ø Swage (Ref.) Ø Press. (Rif.)	"HSS" Fitting Raccordo "HSN"	Skiving length Lungh. di pelatura	Ø Swage (Ref.) Ø Press. (Rif.)				
DN	Inch	Dash	Part.N.	mm	mm	Part.N.	mm	mm	Part.N.	mm	mm	Part.N.	mm	mm	Part.N.	mm	mm	Part.N.	mm	mm	Part.N.
31,5	1 1/4"	-20	HSS20	54	51,6	HSS20	54	51,6													SCS20
38	1 1/2"	-24	HSS24	69	61	HSS24	69	61													SCS24
51	2"	-32	HSS32	80	73																SCS32